

Ventilation control for SupraBox COMFORT 800 to 5000

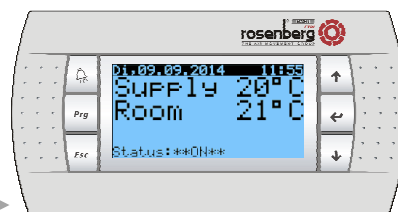

Suprabox



User Terminal

1 Index

1 Index	3
2 General Information	4
3 Safety	4
4 Definition of Qualified Personnel	5
5 Normal Operation / Scope of validity	5
5.1 Normal operation	5
5.2 Scope of validity	5
6 Description	6
6.1 Technical Data	7
6.2 Terminal configuration	7
6.3 Scope of delivery of the Control System	8
7 Installation	8
7.1 Assembly / Initiation	9
7.2 Lead Colours	10
7.3 Identification of Electric Accessories	10
8 Brief Instruction	11
8.1 Key Configuration	11
8.2 Main display	12
8.3 Switch On/Off the Unit	14
8.4 Menu-Overview	14
8.5 Setting the Temperature	16
8.6 Setting of the Fan intensity	17
8.7 Activating the automatic operation	18
8.8 Alarm Display, Alarm Message and Warnings	20
8.9 Unit settings, initial operation	23
8.10 Language Settings	24
8.11 Time and Time Programs	24
8.12 Manufacturer Information, Service information and System information	26
8.13 Real value display (Status I/O)	28
8.14 USB- Port for Software Update	29
8.15 Optional accessories	30
9 Service Menu	33
9.1 Enter the service menu	33
9.2 Working hours	33
9.3 Alarm Memory	33
9.4 Bus connection	34
9.5 Guided Setup	34
9.6 Manual operation	41
9.7 Setup Menu	41
10 Parameter list	42
11 Storage, Transport	45
12 Maintenance, Servicing	45
13 Accessories and Field devices	45
14 Copyright	48
15 Customer Service, Manufacturer's address	49
16 Initial Operation Report	50
17 Notes	51

2 General Information

This operating manual contains important technical and safety information.

Read this operating manual carefully before unpacking, mounting, commissioning and for other maintenance and service activities on the control device.

It must be ensured that the operating manual is accessible and available during the operation of the **ventilation unit type SupraBox COMFORT (SBC)**.

An operator of the electronic must read the operating manual carefully and understand the information before unpacking, mounting, commissioning and for other maintenance and service activities on the control device.

If there are further questions regarding installation, operation or maintenance please consult our sales department.

3 Safety

The following icons show certain hazards or give advice for the safe operation.



Caution! Danger zone! Safety advice!



Hazardous electricity or high voltage!



Caution! Hot surface!



Important advice, Information



This unit carries hazardous electric current and controls rotating, mechanical parts. Death, grave physical harm or substantial damage to property may occur, if the instructions of the operation manual are not observed.







Only qualified personnel should work on the units. These personnel must be familiar with all warning instructions and actions to install and use the unit according to the manual. The successful and safe operation of the unit is dependent on the correct transport, assembly use and maintenance.



Do not install the unit in places with current conducting dust, corrosive or flammable gases, humidity, rain or excessive heat or pollution.



SupraBox COMFORT Control is not protected against explosion (Directive 94/9/EG).



	It is strictly forbidden to perform work on live electrical equipment. Protection rating of the open unit is IP21! Contact with dangerous voltage is possible.
	The unit operates with alternating current. The current level must correspond to the value on the name plate. The suprabox Comfort and the integrated switch cabinet must be closed during the operation.
	Repairs may only be made by specialists authorized by Rosenberg Ventilatoren GmbH. Only replace circuit breakers, do not repair or bridge them. Only use fuses which are indicated in the wiring diagram. Check the zero-potential using a bipolar voltage tester.
	The wiring of the SupraBox COMFORT Controller or the assembly with the article number H42-73**** must be carried out according to the connection schematic. Wrong connections lead to the destruction of the unit. Deficiencies of electrical installations/assemblies/equipment must be repaired immediately. If there is imminent danger do not operate the unit/assembly in defective condition.

4 Definition of Qualified Personnel

<p>According to the operation manual and the warning instructions, qualified personnel are persons who are familiar with installation, assembly, initialization and operation of the product and have the following qualifications:</p> <ul style="list-style-type: none"> - Training or instruction i.e. authorization to switch power and equipment on and off, to ground and to mark circuits and devices according to the standards of safety engineering. - Training or briefing in maintenance and use of appropriate safety equipment according to the standards of safety engineering. - Training in first aid. 	
--	--

5 Normal Operation / Scope of validity

5.1 Normal operation

<p>The Controller or the assembly with the article number H42-73**** optionally equipped with an interface-card is exclusively developed and intended for the tasks as control, regulation and monitoring for the Rosenberg ventilation unit Supra Box COMFORT (SBC). Other uses or uses above their intended use are prohibited unless contractually agreed upon. The manufacturer is not liable for damages which might occur by use of the product for something other than its intended purpose. The user assumes all risks.</p>	
	It is part of the intended use to obey the operations described in this manual for the assembly, operation and maintenance.
	We point out that this operation manual is only valid for the device and not for the complete installation!

5.2 Scope of validity

<p>The scope of validity of this manual includes the following control versions or the assembly with the article number H42-73****:</p> <ul style="list-style-type: none"> -temperature and ventilation for SupraBox COMFORT (SBC) for series 800-5000 	
--	--

6 Description

The control units or the assembly with the article number H42-73**** have been specially constructed for the control of Rosenberg Ventilatoren GmbH compact appliance series Suprabox Comfort (SBC) and represent the epitome of convenience, safety of use, control and maintenance of the equipment. The control units are produced according to the German VDE guidelines and meet the requirements of the valid EG-regulation (DIN EN 60204-1 and others).

The following functions are included in the control system and can be activated if necessary:

- Temperature control of the supply air and room temperature respectively for the use of
PWW register and systems (pump warm water)
EEH systems (single-stage electrical heating)
PKW register and systems (pump cold water)
- Temperature control of the supply air and room temperature respectively for the use of direct evaporator and systems with on-site interface boards for example CompTrol Interface III (Producer Mitsubishi / Stulz) or PAC IF011B (producer Mitsubishi)
- Temperature control of the supply air and room temperature respectively for the use of set-point compensation according to the outside temperature conditions in winter and summer and taking into account the energetic temperature conditions, cool-night air function, Mixed air function, Standby mode
- Temperature control of the supply air and room temperature respectively for the use of heat recovery system
PWT countercurrent plate heat exchanger system
RWT rotary heat exchanger system
- Temperature control of the supply air and room temperature respectively for the use of Fresh air and return air dampers
- Automatic mode with step less control and monitoring of the EC-Fans
- Automatic mode with control of the fans and operation with the help of a selectable demand sensor (speed, volume flow, pressure)
- Overriding of the fans upon requests by external switch contact or a selectable demand sensor (Temperature, humidity, CO₂, VOC)
- Airflow monitoring
- External running mode and collective fault signal
- Program sequence for defrosting / de-icing of the heat recovery, preheating
- Anti-Blocking protection for the pump PWW- (pump warm water) and PKW- (pump cold water) system
- Anti-Freeze protection for PWW- (pump warm water) system
- Overheating control EEH- System
- Automatic mode with adjustable weekly program with 6 switching times and 3 profiles per weekday
- Automatic mode with indication of the actual value, state and alarm, alarm memory, manual activation of the outputs
- Loading of the program routine via USB- Interface
- Room operating device with simple settings on the program routine
- Communication- Interface card with different transmission protocol (Modbus, Bacnet)
- Display German and English

6.1 Technical Data

Nominal voltage:	AC 230/400V 50Hz (+6% / -10%)
Control voltage:	AC 24V 50Hz, disconnected galvanically from the mains voltage
Ambient temperature	-20°C to +60°C max. 90%r.F.
Operating device and IP protection type of the external operat- ing device	IP40 for wall mounting / IP65 for front mount- ing
Wire connection from the control to the operating device	Li9YY6 not crossed with RJ 11 Telephone plug, 10m cable enclosed length max.: 50m (without TCONN6J000)
Conductor	NYM-J 3x2,5mm ²
Maximum power of the alarm relay	AC 250V 10A for 1,5mm ² core cross-section



The alarm relay energizes as soon as the Suprabox COMFORT (SBC) is live.
In case of an alarm or the interruption of the voltage supply the relay de-energizes.

6.2 Terminal configuration



The terminal configuration has to be performed exclusively according to the valid wiring.

The electric potentials must be observed when mounting and wiring. Incorrect wiring may damage the electronic circuit or lead to wrong logically program routine.

If after reading the operating instructions and the circuit diagram there are still some questions regarding installation, operation or maintenance please contact the Rosenberg Ventilatoren GmbH.

6.3 Scope of delivery of the Control System





	<ul style="list-style-type: none"> • Control: Controller Item Number H42-00400 with connecting plug Item Number H42-00401 or the complete assembly Item number H42-73**** integrated in the Ventilation Unit SupraBox COMFORT (SBC) • Operation and display: Control panel Item number H42-00104 or H42-00102, to be connected with the Controller via connecting cable • Connecting cable: 10m flat cable Item number TF5-20012 with 2 pieces tab connectors Item number TF5-20011, pre-assembled • Operating instructions Doc. No. BA 415 AA 09/14/A/ Edition 1, updated edition • Circuit documentation, circuit diagram • Program Routine SupraBox COMFORT is already loaded in the Controller
--	---

7 Installation

	<ul style="list-style-type: none"> - Check the rightness of the the article number of all delivered components from the assembly control and the ventilation unit SupraBox COMFORT (SBC) with the delivery note date, the technical data and the planning data in the circuit diagram. Damages and costs due to mistakes can be avoided. - Unpack the components and check for damages. Damages shall be reported immediately to the supplier or the manufacturer Rosenberg Ventilatoren GmbH. Damaged and defected components or assemblies must not be put into operation.
	<p>Read operation manual and safety instructions carefully. Please note the safety symbols on the ventilation unit SupraBox COMFORT (SBC). Take care that every user of the SupraBox COMFORT reads the operation manual before initiation. The operation manual must be accessible to everybody.</p>
	<ul style="list-style-type: none"> - The unit may not be installed in places with current conducting dust, corrosive or flammable gases. Protect the control and operating device from humidity, rain or heat.
	<ul style="list-style-type: none"> - The control is operated with alternating current voltage. Obey the instructions on the type plate of the ventilation unit SupraBox COMFORT (SBC).
	<ul style="list-style-type: none"> - Electrical installation of the equipment, the mains voltage and the external operating devices must be made according to the valid circuit diagram. The electrical potential must be observed during the wiring. Incorrect wiring can cause permanent damage to the electronic or lead to wrong logical program routine.
	<ul style="list-style-type: none"> - Electrical connection may only be made by an authorized electrician according to the German VDE regulations and the instructions of the local electrical power supplier in your region. Connection must be made exactly according to the circuit diagram and the configuration diagram. Check all screw joints and retighten them if necessary.
	<ul style="list-style-type: none"> - The main switch fixed at the control terminal of the SupraBox COMFORT (SBC) must be freely accessible. The phases must be connected to the main switch. - The consumers (fans, pumps) as well as control units (actuators, valve actuator) can with conventional cables are wired which is sufficient for the current carrying capacity and thermal load.

- The collective alert contact is a changeover contact, which displays malfunctions of the equipment. The relay is energized, if there is voltage supply and no malfunction. In case of alarm message, the relay will de-energize and keep this status until the malfunction is repaired and the current alert will be acknowledged at the operating device.

7.1 Assembly / Initiation

	<p>Preparing the SupraBox COMFORT (SBC) for initial operation:</p> <ul style="list-style-type: none"> ▪ Proper mechanical assembly ▪ Electric connection according to instructions ▪ Remove foreign particles in the suction and exhaust area and in the complete SupraBox COMFORT (SBC) ▪ Please observe the necessary normative, regulations and directives (for example EN 60204-1) for a continuous protective conductor system, for equipotential banding and for automatic switch-off of the supply voltage to avoid dangerous situations.
	<p>Check the supply cables before assembly if there is absence of tension after you have saved the the electrical protection against reactivation. The ventilation unit leads after connecting to the supply line dangerous electrical tension and controls rotating mechanical parts.</p> <p>Assembly the electrical components only when the mechanical ventilation system parts are permanently installed on their intended place.</p>
	<p>The fans must rotate completely smoothly and without jolt at every motor speed.</p>
	<p>The control and the electrical accessories must be connected according to the connection diagram. Faulty connections will cause destruction of the unit.</p>
	<p>The user is bound to operate the devices only in proper working condition. Danger zones which can exist between the Rosenberg Ventilatoren GmbH units and installations on the customer side must be safeguarded by the user!</p>

7.2 Lead Colours

Main current:		Control wire:	
L1 ⇒ black	N ⇒ blue	24V AC ⇒ red	24V DC ⇒ violet
PE ⇒ yellow/green		24V AC ⇒ red-white	24V DC ⇒ violet-white
		External voltage / Alarm relays	orange

The isolation of the individual electrical conductor (strand) is performed in the shown colours for the purpose of labelling.

7.3 Identification of Electric Accessories

Code letter	Type of Accessories	Examples
A	Assemblies	Amplifier as assembly
B	Converter	Measuring converter, microphone
C	Capacities	Condenser
D	Memory, delay device	UND-link, magnetic tape recorder
E	Miscellaneous	Light, heating
F	Protection equipment	Fuse, actuator
G	Generators, power supply	Machine generator, oscillator
H	Annunciator	Signal unit
K	Relays, contactors	Auxiliary contactor, main contactor
L	Inductors	Coil
M	Motors	Polyphase motor, direct current motor
N	Amplifier	Measuring amplifier
P	Measuring amplifier	Voltmeter
Q	High voltage current devices	Circuit breaker, automatic interrupter
R	Resistors	Thermal resistor
S	Switch, selector	Key, rotary switch
T	Transformers	Voltage transformer
U	Modulators	Frequency converter
V	Tubes, semi-conductors	Diodes, Transistors
W	Transmission	Cables, waveguides
X	Clamps	Socket-Outlet
Y	Electric mechanics	Break
Z	Escape, Filter, Balance	Compandor

The integral components complete assembly Art. No. H42-73**** integrated in the ventilation unit SupraBox COMFORT (SBC) are like the labeling in the circuit documentation (circuit diagram).

8 Brief Instruction



The Controller restarts after the supply voltage is switched on and shows the main display with the supply temperature and the plant status. If within 60s no keystroke is recognized, the display changes from every sub-menu automatically back to the main display.

8.1 Key Configuration

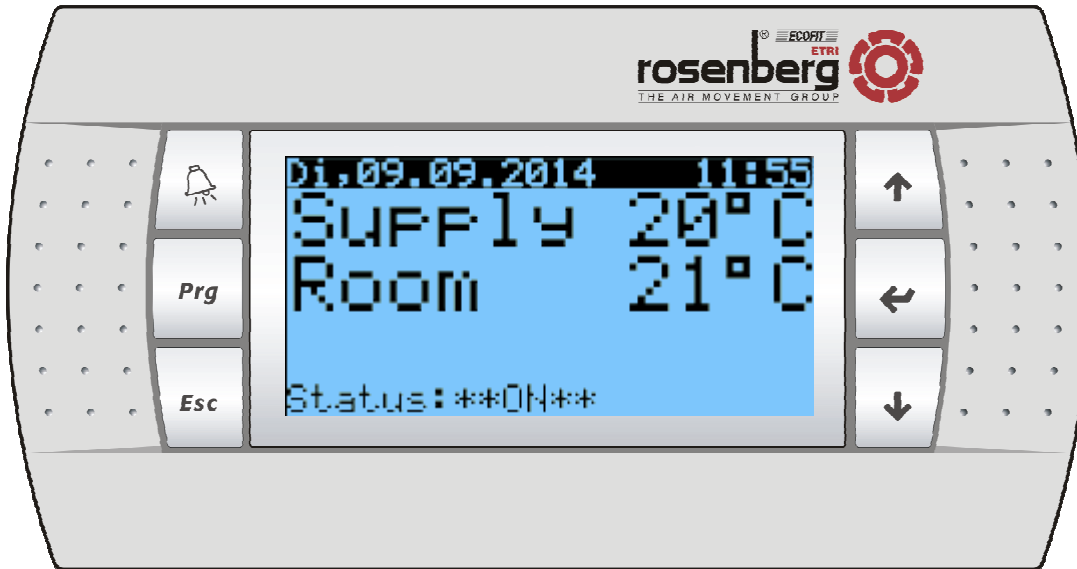







Image: Operation and main display



<p>Key [ALARM]</p> 	<p>Flashes red if an error occurred. Displaying of the upcoming alarms by operation Acknowledging of eliminates interferences after operation Returning to the main display after operation</p>
<p>Key [Prg]</p> 	<p>Selection of the menu-overview and the main-menu pages by operation</p>
<p>Key [Esc]</p> 	<p>Returning to the menu-overview and the main-display by operation When operating during a change of values of parameters it will switch to the higher level (menu-overview-display). There is no guarantee that the previous parameter value remains.</p>
<p>Key [Up] Arrow key „up“</p> 	<p>Change the display in the menu-overview and for the in-and output sides by operation Changing or raising a parameter value (setting value) for the value adjustment</p>

<p>Key [Down] Arrow key „down“</p> 	<p>Change the display in the menu-overview and for the in-and output sides forward or downwards by operation</p> <p>Changing or reducing a Parameter value (setting value) for the Value adjustment</p>
<p>Key [Enter] Arrow key „middle“</p> 	<p>Choosing of the current adjustable parameter value for processing after operation</p> <p>Confirming the current adjustable parameter value after processing after operation</p> <p>On and Off switch of the program routine or the controller or the ventilation unit by a continuing actuation (only for displaying in the main display)</p>

8.2 Main display





Main display

	<p>Display for the supply temperature in °C</p> <p>The current measurement of the sensor will automatically be updated and displayed.</p>
	<p>Display for the room or return temperature in °C following the selection</p> <p>Selection for displaying the control temperature in the <i>programming level > commissioning > Temperature control</i></p> <p>The current measurement of the sensor will automatically be updated and displayed.</p>
	<p>Display for the plant status. The possible text are:</p>
	<p>Status OFF, Status ON, Status START-UP, Status SUPPORT, Status PRE-HEAT, Status COOL RECOVER, Status DEFROST, Status STOP RUN, Status ALARM, Status OVERDRIVE, Status AUTO-OFF</p>
<p>Key [Enter] Arrow key „middle“</p> 	<p>Automatic operation</p> <p>On and Off switching of the program routine or the control or ventilation unit by a continuing actuation</p>
<p>Key [Prg]</p> 	<p>Selection of the Menu-Overview and the menu pages by operation</p> <p>From the main display you can go while pressing the [Prg] key <i>to the main menu</i></p>

**Automatic operation:**

The automatic operation can be manually activated by pressing the [Enter] key or through the time program or with an extern switch or through an optional accessory zone operating device.
This functions can be deselected in the display Menu-Overview at Settings



8.3 Switch On/Off the Unit

<p>Key [Enter] Arrow key „middle“</p> 	<p>Automatic operation On and Off switching of the program routine or the control or the ventilation unit by a continuing actuation for display of the main display.</p>
	<p>Automatic operation: The automatic operation can be manually activated by pressing the [Enter] key or through the time program or with an extern switch or through an optional accessory zone operating device. This function can be deselected in the display <i>Menu-Overview > Settings</i> Additional information in the chapter optional accessories.</p>

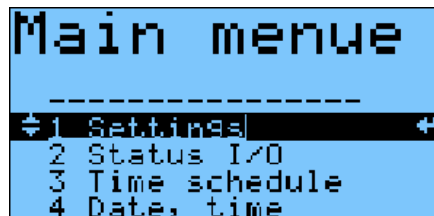
8.4 Menu-Overview



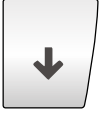

<p>Key [Prg]</p> 	<p>From the main display you can go to the main menu with the key [Prg] Selection of the Menu-Overview and the menu pages by operation</p>
---	---

<p>Key [Up] Arrow key „up“</p>  <p>Key [Down] Arrow key „down“</p> 	<p>To be used to switch between the display or in the main menu, or to scroll.</p> <p>The possibilities to be chosen are:</p> <ul style="list-style-type: none"> 1 = Settings 2 = Status I/O 3 = Time schedule 4 = Date, time 5 = System info 6 = Language 7 = Program <p>To be used to adjust the password at the password entry level</p>
<p>Key [Enter] Arrow key „middle“</p> 	<p>Selection of the menu group Switching in the selected input and output sides Switching to the selected program levels with the password request</p> <p>Password Level Service = 0077 Password Level Service and Unit configuration = 0123</p> <p>The password will be reset after a selected time.</p>



Service menu after the password request



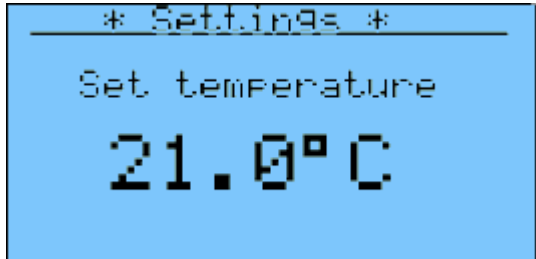

<p>Key [Up] Arrow key „up“</p>  <p>Key [Down] Arrow key „down“</p> 	<p>To be used to switch between the display or in the main menu, or to scroll.</p> <p>The possibilities to be chosen are:</p> <ul style="list-style-type: none"> 1 = Hours counter 2 = Alarm history 3 = Communication
---	--

<p>Key [Enter] Arrow key „middle“</p> 	<p>Selection of the menu group Switching in the selected input and output sides Switching to the selected program levels with the password request</p>
--	--

8.5 Setting the Temperature



Set point to Menu-Overview > Settings

	<p>The temperature set point can be set manually in the menu <u>Settings</u>. The input value is the manual set point for the comfort temperature to heat and cool.</p> <p>By pressing the key [Enter] while <u>Setting</u> is marked the display for temperature set point on the electronic controller is called.</p>
<p>Key [Up] Arrow key „up“</p>  <p>Key [Down] Arrow key „down“</p> 	<p>In the display changes or increase/reduce of the parameter value:</p>
<p>Key [Enter] Arrow key „middle“</p> 	<p>In the display: Choosing of the current adjustable parameter value for operation The Cursor / pointer jumps on the setting value manual temperature value-set point. Confirming of the current changed parameter value setting value manual temperature set point.</p>



The display of the room-/return temperature in °C is made upon selection or setting of the control temperature for the Temperature-Set point:
 The selection takes place in the *programming level > initial operation > Temperature control*
 The current measurement of the sensor will be automatically displayed and updated.

8.6 Setting of the Fan intensity



The ventilation intensity can be set in the menu *settings*. The display can be shown or hidden according to the settings during the initial operation. The entries are manual set point standards for the supply air and the return air fan.

```

* Settings *
  PI- control
Manual setpoint fans
Rotation supply: 040 %
Rotation return: 040 %
  
```

Speed set point setting scaled in %
 to find at Display *Menu-overview > Settings*

```

* Settings *
  Pressure control
Manual setpoint fans
Supply:      1000 Pa
Return:     1000 Pa
  
```

Speed set point setting scaled in Pa
 to find at Display *Menu-Overview > Settings*

```

* Settings *
  Volume control
Manual setpoint fans
Supply:     5000 m3/h
Return:    5000 m3/h
  
```

Speed set point setting scaled in m³/h
 to find at Display *Menu-Overview > Settings*

By pressing the key [**Enter**] while setting is marked the display for air volume or ventilation intensity on the electronic control can be seen. The display is in the display list of the settings. With the key [**Up**] or the key [**Down**] you can switch to the display below.

The display of the setting for the fan operation can be chosen with the defaults *programming level > Initial operation > Fan setting*

Key [**Up**]

Arrow key „up“





Key [**Down**]

Arrow key „down“



In the display changes or increase/reduce of the parameter value:



<p>Key [Enter] Arrow key „middle“</p> 	<p>In the display; Choose the current adjustable parameter value for operation The Cursor / pointer jumps to the setting value manual temperature value-set point.</p> <p>Confirming of the current changed parameter value setting value <u>manual temperature set point.</u></p>
--	--

	<p>During the automatic operation the ventilation intensity will be automatically calculated. A distinction is made here between two variants:</p> <ol style="list-style-type: none"> 1. If there is an external sensor for moisture measurement, air quality measurement or pressure measurement with a 0-10 V out, the sensor value is applied in order to determine the optimal ventilation demand. The volume flow measurement takes place with the connected sensors and the installed air tubes. With the default setting volume flow the automatic mode can be set with selected sensor or sensor values. 2. The used sensors for the automatically modification of the ventilation intensity can be from the type temperature, humidity, air quality VOC and CO₂ concentration. The larger the current temperature deviation the more is ventilated. The Fans were operated therefore in three stages. <p>See also chapter activating the automatic operation (release according to the default in the programming level)</p> <p>Other setting values in the display <u>programming level >initial operation >Fan settings.</u></p>
---	--

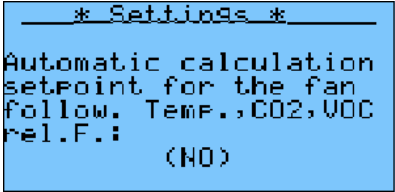
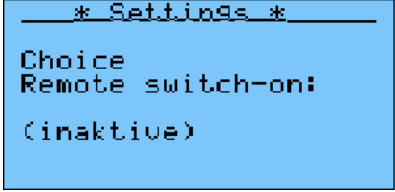
8.7 Activating the automatic operation

	<p>The ventilation intensity, external running mode, the activation of the time program, the back-up mode and night air can be set in the menu settings. The display can be shown or hidden according to the settings during the initial operation.</p>
	<p>By pressing the key [Enter] while the <u>settings</u> are marked, one of the display below the electronic controller can be invoked. The display is in the display list of the settings. With the Key [Up] or Key [Down] you can switch to the display bellow.</p>
	<ol style="list-style-type: none"> 3. <i>During the automatic operation the ventilation intensity will be automatically calculated. By selecting, the control type will be activated or deactivated for operation of the fans. The used sensors for the automatically modification of the ventilation intensity can be from the type temperature, humidity, air quality VOC and CO₂ concentration. The larger the current temperature deviation the more is ventilated. The fans were operated therefore in three stages.</i> <p>Other setting values in the display <u>programming level >initial operation >Fan settings.</u></p>
	<p>The automatic operation can be activated through an external switch or key with adjustable operation time per program routine. The activation of the signal contact or signal input at the electronic controller is activated by the choice or deactivated by deselection. If the weekly program is activated, the configured times and set points were used. Other setting values in the display <u>Menu-Overview>time program. Standards issued by the manufacturer are in the display program level >initial operation>comfort function.</u></p>





<pre> * Settings * Choice Daily and weekly Programm: (NO) </pre>	<p>The user has the possibility to activate the internal time program of the electronic controller.</p> <p>Through a selection the weekly program is activated or by deselection deactivated. If the weekly program is activated, the configured times and set point were selected. Further setting values in the display <u>Menu-Overview>time program.</u></p>
<pre> * Settings * Choice support mode heating: (NO) cooling: (NO) activates ventilation at temp. deviation </pre>	<p>Activating the back-up mode heating or cooling.</p> <p>The menu is displayed only with connected room temperature sensor and release heating or cooling.</p> <p>At the back-up mode heating the adjustable temperature should not be reduced also at inoperative status of the unit. At the back-up mode cooling the adjustable temperature should not be reduced also at inoperative status of the unit. The unit automatically switches on when the adjustable limiting values were exceeded. The unit runs in the back-up mode at least for the time set. Set the limit values and the maturities in the programming level at <u>>Program level > initial operation >comfort function</u></p>
<pre> * Settings * Choice Night cool-recover: (NO) </pre>	<p>Activating of the function night air by using the energetic Temperature-Potential. The menu is displayed only for connected external-and room sensors.</p> <p>Certain temperature condition allows in summer an air exchange in the room at night. When during the day a high temperature has heated up the room and at night a cooling of the room temperature with cool outside air takes place. The outdoor temperature at night must be higher as the set value so that in the cool season an exchange with too cool air can be excluded. At the same time, the room temperature must have at least one set value, so that the room does not cool down through the air exchange. An adjustable minimum value as difference between room and outdoor temperature prevents not efficient ventilation through air exchange. If all premises are given the ventilation runs for the minimum term. The function is only permitted with a connected room and outdoor temperature sensor. Setting of the limit value and terms in the program level at <u>>Program level> initial operation>comfort function</u></p>

<p>Key [Up] Arrow key „up“</p>  <p>Key [Down] Arrow key „down“</p> 	<p>In the display changes or increase/reduce of the parameter value:</p>
<p>Key [Enter] Arrow key „middle“</p> 	<p>In the display; Choose the current adjustable parameter value for operation</p> <p>The Cursor / pointer jumps to the setting value manual temperature value-set point.</p> <p>Confirm the current changed parameter value setting value <u>Menu-Overview > Settings</u></p>



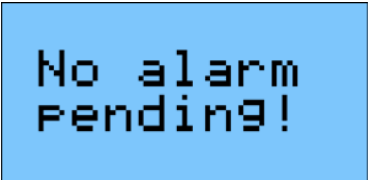

8.8 Alarm Display, Alarm Message and Warnings

<p>>> ALARM << Malfunction Supply fan</p>	<p>An alarm message will be generated, when the return and supply air fan reports a disruption. The fault signal relay from the fan-electronic starts a signal contact to the controller; see circuit documentation or circuit diagram. The fault signals relay on the return and supply air fan delay after switching on the voltage activation. Usually the fault signal relay in the fan electronic is assembled in the factory. In event of an exchange the setting must be verified with the Rosenberg Software EC-Param.</p>
<p>>> ALARM << Malfunction Return fan</p>	<p>Possible disruptions can be :</p> <ul style="list-style-type: none"> Locked rotor, Overheating of the electronic, Overheating of the Motor, Overcurrent, Power supply under voltage, Overvoltage, Over speed, Error power electronics
<p>>> ALARM << Filter supply side is clogged</p>	<p>An alarm message will be generated, when the return and supply filter is dirty (the maximum pressure deviation of the return filter)</p> <p>A dirty filter must be replaced. Replacement parts can be ordered at Rosenberg Ventilatoren GmbH.</p> <p>The limit value can be adapted in the program level.</p>
<p>>> ALARM << Filter return side is clogged</p>	
<p>>> ALARM << Fire, smoke detected</p>	<p>A smoke alarm or signal contact to a central fire alarm system/a fire protection flap can be connected to the Suprabox Comfort. The behavior in case of alarm can be adjusted on startup of the unit. After the alarm is acknowledged, the Suprabox Comfort continues normal operation.</p>
<p>>> ALARM << Malfunction frost</p>	<p>The water heater is supplied with a capillary contact, which opens in case the frost protection temperature falls below the minimum level. After that the mixing valve of the heating coil will be totally opened, the circulating pump started, the fans stopped and the external air damper closed. When the capillary contact closes, the unit re-starts after a certain time which can be determined. After the frost protection alarm is tripped three times (within 2h) the unit is stopped until it is manually restarted at the operator panel. Before the manual restart the cause of the alarm must be verified. The SupraBox COMFORT (SBC) starts again the normal operation when the disruption at the signal input is no longer recognized.</p>
<p>>> ALARM << Fault at internal temperature sensors or no connection</p>	<p>Three internal temperature sensors are integrated in the unions of the Suprabox Comfort for the measurement of return air, fresh air (during the operation of the Suprabox Comfort) and to measure the temperature after the heat recovery. An alarm is initiated in case that one or several sensors are incorrectly connected or defective. In case of error the unit will be stopped until it is acknowledged.</p>



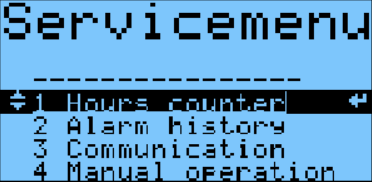

<p>>> ALARM <<</p> <p>Fault at sensor supply temperature or no connection</p>	<p>For the correct operation of a heating or cooling coil a supply temperature sensor is needed. If a heating or cooling coil is released during the re-start, an alarm will be initiated in case that the duct sensor is missing or not recognized correctly. The unit will be stopped until the error is acknowledged.</p>
<p>>> ALARM <<</p> <p>Safety temp. limiter Electrical heater</p>	<p>The electric heater is equipped with an internal overheat control. When an alarm is tripped it is indicated as an alarm message on the operation panel and the heater is stopped until the error is acknowledged. The fans will run at high speed for 10 minutes, afterwards the Suprabox is completely stopped until the error is acknowledged.</p>
<p>>> ALARM <<</p> <p>Safety temp. limiter Electrical Preheater</p>	<p>A temperature control is attached at the pre-heater. If the temperature of the heating coil exceeds the limit, an error is indicated and the heating stopped until the errors are acknowledged. The fans will run at high speed for minutes, afterwards the Suprabox will be completely stopped until the error is acknowledged.</p>
<p>>> ALARM <<</p> <p>Frost detected at Heat Recovery System</p>	<p>The differential pressure control monitors the reverse flow heat exchanger for frost. On startup of the unit, the type of defrosting can be determined.</p> <ol style="list-style-type: none"> 1. If an imbalance of the fans is allowed, in case of frost the fresh air fan will be reduced for 5 minutes by 30% in order to encourage defrosting by the warmer return air. 2. If an electric pre-heater is installed and released, it will be activated in case of frost in order to heat the fresh air and thus defrost the heat exchanger. 3. If both variations have been allowed the fresh air will be reduced first. If this is not sufficient the pre-heater will be started after 5 minutes. 4. If no action was successful or neither variation is possible, the Suprabox Comfort will be deactivated and an alarm indicated. It is not necessary to acknowledge the alarm. After 10 minutes the Suprabox Comfort starts the fans automatically. <p>The time intervals are configurable in the program level <i>Program level > initial operation > Fan setting</i></p>
<p>>> ALARM <<</p> <p>Modbus Master no contact to Slaves</p>	<p>The internal temperature sensors and continuous pressure sensors are connected to the control by a bus. If the bus connection does not work correctly an alarm message is indicated. The Suprabox Comfort will be deactivated until the error is removed and the alarm acknowledged.</p>
<p>>> ALARM <<</p> <p>Malfunction external cooling unit</p>	<p>The refrigerator / direct evaporation unit is provided with a fault signaling contact. If an alarm occurs this is shown as a message on the control panel. With the release of the refrigerator in the program level the Suprabox Comfort will be deactivated until the error can be rectified and the alarm cancelled.</p>

<p>Key [ALARM]</p> 	<p>Flashes if an error occurred in red. Showing of current alarms by operation Acknowledge of eliminates interferences after operation. Return to the main display after operation</p>
<p>Key [Up] Arrow key „up“</p>  <p>Key [Down] Arrow key „down“</p> 	<p>Switching between different active alarms.</p> <p>Switching to the previous display.</p> <p>Switching to the below display.</p>
	<p>If all faults are eliminated no alarm can be displayed. When pressing the key [ALARM] the display at your left is displayed.</p>
<p>Key [ALARM]</p> 	<p>Flashes if an error occurred in red. Showing of current alarms by operation Acknowledge of eliminates interferences after operation. Return to the main display after operation</p>

8.9 Unit settings, initial operation

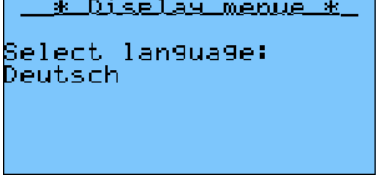



 <p>Password request</p>	<p>By pressing the key [Enter] while the <u>program level</u> is marked, the password displayed on the controller can be opened. The following displays are not generally available. With the key [Up] or Key [Down] you can switch to the menu display.</p> <p>The basic settings for the commissioning can make changes at the unit type SupraBox COMFORT (SBC).</p>
 <p>Service menu after password request</p>	
	<p>The basic settings for the unit type SupraBox COMFORT (SBC) are manufacturer entries and cannot be changed without consultation with Rosenberg Ventilatoren GmbH.</p>
<p>Key [Up] Arrow key „up“</p>  <p>Arrow key [Up] Arrow key „down“</p> 	<p>To be used to switch between the display or in the main menu, or to scroll.</p> <p>The possibilities to be chosen are:</p> <ul style="list-style-type: none"> 1 = Hours counter 2 = Alarm history 3 = Communication 4 = Manual operation 5 = Commissioning 6 = Driven commission. 7 = Service info
<p>Key [Enter] Arrow key „middle“</p> 	<p>Selection of the menu group Switching in the selected input and output sides Switching to the selected program levels with the password request</p> <p>Password Level Service = 0077 Password Level Service and Unit configuration = 0123</p> <p>The password will be reset after a selected time.</p>

8.10 Language Settings

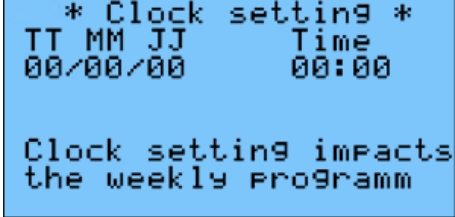
 <p>Display time setting <u>Menu-Overview</u> > <u>Menu language</u></p>	<p>The operating interface is available in several languages and can be changed.</p> <p>By pressing the key [Enter] while the <u>Menu language</u> is marked, the display on the controller can be opened.</p>
<p>key [Up] Arrow key „up“</p>  <p>Key [Down] Arrow key „down“</p> 	<p>In the display changing the parameter value language.</p> <p>Setting German or English</p>
<p>Key [Enter] Arrow key „middle“</p> 	<p>Confirming in the display the current changed parameter value setting language.</p>
	<p>The additional language English must be previously loaded with the program routine. If the additional language (English) does not appear you must contact the manufacturer Rosenberg Ventilatoren GmbH.</p>

8.11 Time and Time Programs

 <p>Display time setting <u>Menu-Overview</u> > <u>Date, Time</u></p>	<p>By pressing the key [Enter] while <u>Date, Time</u> is marked, the display on the controller can be opened.</p> <p>Two time settings can be effected: Adapt the current date and time The current time is set in hh:mm (hours: Minute) and the date in dd.mm.yy (Day / Month / Year).</p>
--	---

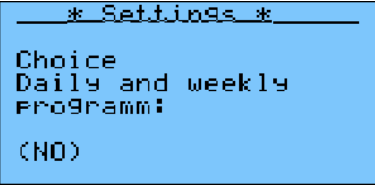
<p>Key [Up] Arrow key „up“</p>  <p>Key [Down] Arrow key „down“</p> 	<p>In the display: Changing of a parameter value of date or time. Switching to other menu display.</p>
<p>Key [Enter] Arrow key „middle“</p> 	<p>In the display: Confirming the current changed parameter value of time and date</p>
	<p>Update of time and date has influence on the time program and the automatic operation.</p>
	<p>By pressing the key [Enter] while <i>settings</i> are marked, the display on the controller can be opened. The display in the display list of settings. With the key [Up] or key [Down] you can switch to the display below.</p>
 <p>Selection time program in the Program Routine Settings to be found in display <i>Menu-Overview > Settings</i></p>	<p>Activation of the internal time program of the controller. Through a selection the weekly program can be activated or by deselection be deactivated. If the weekly program is activated the configured time and set points were used.</p>
	<p>By pressing the key [Enter] while the <i>time schedule</i> is marked, the display on the controller can be opened. The display in the display list of the time program. With the key [Up] or key [Down] you can switch to the display below.</p>

<pre>* Setpoint setting *</pre> <pre>- SET 2 -</pre> <pre>Temperature: 21.0°C</pre> <pre>Auto mode : (NO)</pre> <pre>Volume control:</pre> <pre>Supply fan : 01000m3/h</pre> <pre>Return fan : 01000m3/h</pre> <p>Time program Set point selection Settings to be found at <i>Menu-Overview</i> > <i>time program</i></p> <pre>* Daily program 1 *</pre> <pre>00:00 - 06:00 OFF</pre> <pre>06:00 - 10:00 SET1</pre> <pre>10:00 - 12:00 OFF</pre> <pre>12:00 - 19:00 SET1</pre> <pre>19:00 - 22:00 OFF</pre> <pre>22:00 - 23:00 OFF</pre> <pre>23:00 - 23:59 OFF</pre> <p>Time program time interval selection Settings to be found at <i>Menu-Overview</i> > <i>time program</i></p>	<p>Three time programs are available set point (SET 1 to SET 3):</p> <ul style="list-style-type: none"> - Setting of the temperature set point - Setting of the Fan set point (sensor selection) <p>Four time intervals of the weekly program (daily schedule 1 to daily schedule 4) for the set points (SET 1 to SET 3) are available:</p> <ul style="list-style-type: none"> - Setting of the Temperature set point SET 1 to SET 3 - Setting of the plant status OFF = plant off
<div style="text-align: center;"></div>	<p>Be aware that the start date must appear prior to the stop date and that there is no turn of the time within one time frame. Attention! All the switching times from 00:00-23:59h must be programmed.</p> <p>In the picture the plant is programmed as follows: From 0h to 6h the plant is off. From 6h to 10h the plant is on and the set point combination SET 1 is valid. From 10h to 12h the plant is off. From 23h to 23.59h the plant is off. All switching times must be occupied whereby at 0.00h it always starts and at 23.59h it finishes.</p>
<pre>* Weekly program *</pre> <pre>Monday : OFF</pre> <pre>Tuesday : OFF</pre> <pre>Wednesday: OFF</pre> <pre>Thursday : OFF</pre> <pre>Friday : OFF</pre> <pre>Saturday : OFF</pre> <pre>Sunday : OFF</pre> <p>Time program day of the week selection Settings to be found at <i>Menu-Overview</i> > <i>time program</i></p>	<p>There are four time intervals (daily schedule 1 to daily schedule 4) available.</p> <p>For the programming of the weekdays for the ventilation operation.</p> <p>The ventilation can be additionally being converted via standby and input override.</p>

8.12 Manufacturer Information, Service information and System information

<pre>* SYSTEM INFO *</pre> <pre>Rosenberg-GmbH</pre> <pre>Maybachstrasse 1-9</pre> <pre>74653 Kunzelsau</pre> <pre>Tel. 07940/142-0</pre> <pre>Fax. 07940/142-191</pre> <p>Manufacturer address to be found at <i>Menu-Overview > System info</i></p>	<p>By pressing the key [Enter] while the <i>System info</i> is marked, the display on the controller can be opened. The display in the display list of System info. With the key [Up] or key [Down] you can switch to the display below.</p> <p>Shows the address and phone number of Rosenberg Ventilatoren GmbH an.</p>
--	--



In the menu system information for the performance of the plant, of the electronic and of the software is shown. Further display for the software status and operating system can be selected.

Key [Up]

Key arrow „up“



Key [Down]

Key arrow „down“



Changing between different active alarms.

Switching to the previous display.

Switching to the below display.

```
* SYSTEM INFO *
SupraBox COMFORT
and electronic
controller
Version: 3.01 02.09.14
+ModBUS DPT
+ModBUS TH-T
```

Software Version to be found at Menu-Overview > System info

Shows the loaded Software Version.

When updating the software via USB port at the electronic the version must be checked before and after updating.

```
* SYSTEM INFO *
Service company:
```

Service address to be found at Display Menu-Overview > System info

```
*SYSTEMINFO*
Servicefirma:
Max Mustermann
Musterstrasse 12
12345 Musterstadt
1234 56789
```

Example Service address

Shows the entered data of the service company. See example entry



The setting values service company, place and phone number can be found at programming level >initial operation >Service info.

The display is only shown when the service company is entered.

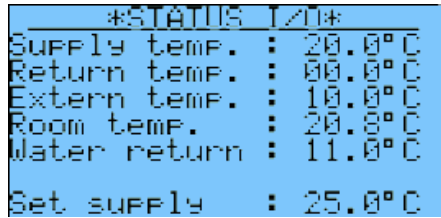
8.13 Real value display (Status I/O)

 <p>Info display No.1 to be found at <u>Menu-Overview > Status I/O</u></p>	<p>By pressing the key [Enter] while the <u>Status I/O</u> is marked, the display can be opened.</p> <p>In the display, the current value of the temperature is shown. The return air and the temperature on the return heating register can be selected during the start up.</p> <p>The shown set point is the calculated set point from the manual set point entry of the time program and the winter/summer compensation.</p>
---	---

	<p>In the menu status I/O information about the plant condition is shown. The display to the In-and Output (measured values, switching signal and corrective signal) were shown or hidden in accordance with the settings during the start up.</p>
---	---

<p>Key [Up] Key arrow „up“</p>  <p>key [Down] key arrow „down“</p> 	<p>Changing between different active alarms</p> <p>Switching to the previous display</p> <p>Switching to the below display.</p>
--	---

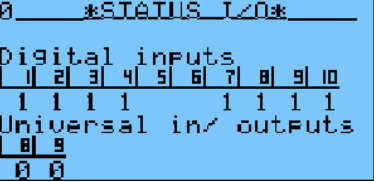
 <p>Info display Digital output to be found at <u>Menu-Overview > Status I/O</u></p>	<p>In a general displaying the status of the signal input can be displayed. The assignment of the function accord with the circuit diagrams.</p> <p>Further display with text for the purpose of assignment signal input and function can be shown through switching / scroll.</p>
---	---

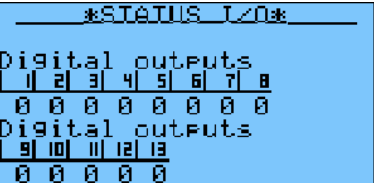
 <p>Info display Digital output to be found at <u>Menu-Overview > Status I/O</u></p>	<p>In a general displaying the status of the signal input can be displayed. The assignment of the function accord with the circuit diagrams</p> <p>Further display with text for the purpose of assignment signal input and function can be shown through switching / scroll</p>
---	---

```

*STATUS I/O*
-----
Analogue outputs
Y1: 00.00V
Y2: 00.00V
Y3: 00.00V
Y4: 00.00V
Y5: 00.00V

```

Info display constant analog Outputs to be found at Menu-Overview > Status I/O

In a general displaying the status of the constant control output (analog) can be shown. The assignment of the function accord with the circuit diagrams

Further display with text for the purpose of assignment signal input and function can be shown through switching / scroll

8.14 USB- Port for Software Update



In delivery condition the current and checked Software version of the SupraBox COMFORT (SBC) is loaded in the electronic control. In case of expansion of the program routine with new functions you can via USB port exchange the software with the program routine.

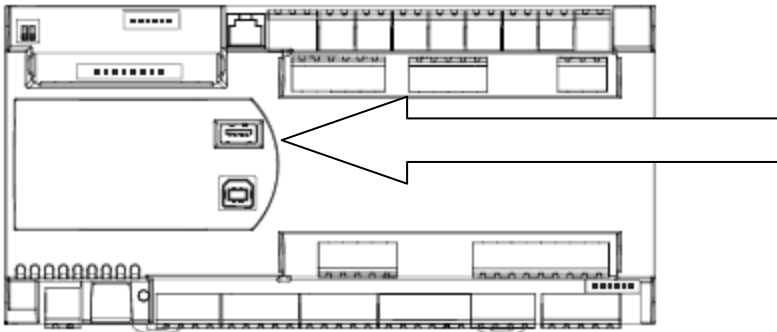

Image: Top view electrical control



After transfer of software with the program routine the USB stick must be removed.



In accordance with Rosenberg Ventilatoren GmbH the transfer of the software with the program routine can be made via e-mail. This is a significant time-saving for service, repair and exchange of electrical control.

Unzip the received compressed file on a USB stick.

Hint:

Directly on top of the drive the file AUTORUN can be found after this command is executed correctly.

In the directory TEST on the drive you can find the 8 necessary program files.

The structure must be adhered for the further procedure.

One of the eight program files contains the default values. The Controller can be moved by copy to the delivery state.

1. The electric control must be connected to the supply voltage. Switch of previously the loads.
2. Insert the USB-Stick in the USB- port, when the controller is started. Confirm with the key [ENTER], when the corresponding display appears (USB- device detected).
.... Wait for other display. This procedure takes up to 2 minutes.

3. Remove the USB-Stick upon request. The electric control restarts and shows the main display with the supply air temperature and the plant status.
4. Switch on the load or activate the automatic mode when you have checked the version in the display.

8.15 Optional accessories

	<p>In delivery condition the current and checked Software version of the SupraBox COMFORT (SBC) is loaded in the electronic control. In case of expansion with optional accessories a selection in the programming level is necessary.</p>
---	---

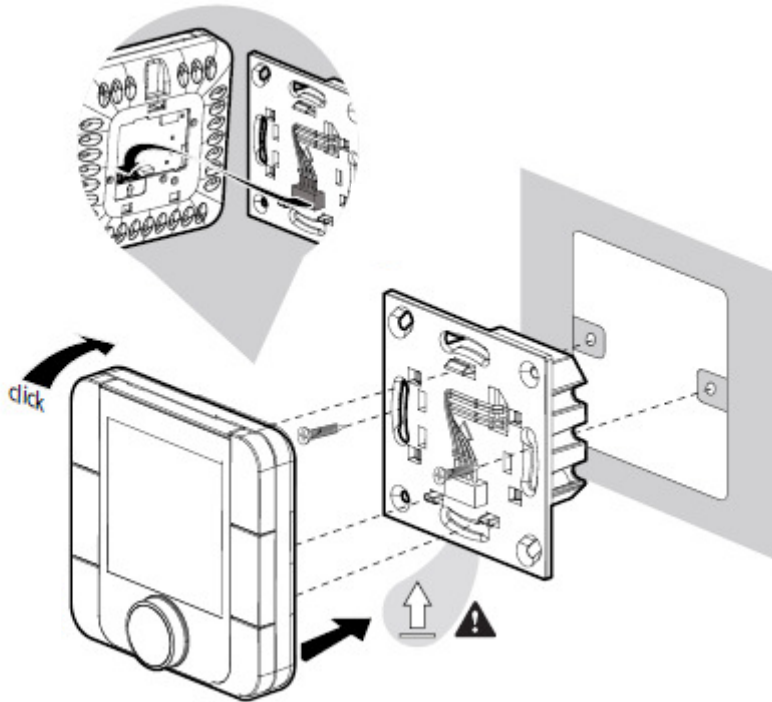

Image: assembly optional zone operation unit and display

<pre style="background-color: #e0f0ff; padding: 5px;"> COMMUNICATION TH Tune Interface at J29 Activation: (NO) </pre> <p>Selection to be found at <i>Menu-Overview</i> <i>> programming level > bus connection</i></p>	<p>Activating of the optional zone operating unit with display. This application extends the control electronic with the possibility of:</p> <ul style="list-style-type: none"> • Set point adjusting with rotary-knob • Manually adjusting the fan steps for time intervals • Switch on and off of the automatic mode
---	--

H42-00111 optional room operating device

Installation: flush-mounted (flush-mounted Installation box)

Supply voltage: 230V AC, 50 Hz (24V AC upon request)

Protection class: IP20

Environmental conditions: -10°C to + 60°C, max. 90% r.F. (non-condensing)

Interface: Modbus Data connection to the control electronic

Software: The control and display are only possible in conjunction with the control electronic of the SupraBox COMFORT. The room operating device is given freely in the control electronic.

Keys: Power (On/Off), Fan (fan / manual air volume), Mode (operating modes effect), CLOCK (hour, finish manual changing air volume), rotary knob (Temperature set point)

H42-00112 optional room operating device

Installation: Wall mounting (with its own plastic housing)

Supply voltage: 230V AC, 50 Hz (24V AC upon request)

Protection class: IP20

Environmental condition: -10°C to + 60°C, max. 90% r.F. (not condensing)

Interface: Modbus Data connection to the control electronic

Software: The control and display are only possible in conjunction with the control electronic of the SupraBox COMFORT. The room operating device is given freely in the control electronic.

Keys: Power (On/Off), Fan (fan / manual air volume), Mode (operating modes effect), CLOCK (hour, finish manual changing air volume), rotary knob (Temperature set point)

The optional room operating device H42-00111 or H42-00112 can be connected as accessory at the control electronic of the SupraBox COMFORT, when control and display were operated at another site. The advantage of this little control and display electronic lies in the clear and simple illustration and influence on the temperature and in the air volume of the ventilation system. Typical applications are restaurants, office rooms and small building zones. Initial operation and settings of the ventilation system limits and threshold values and of the week program are included in the menu of the control and display of the SupraBox COMFORT.

Case 1: Automatic mode / Week program is deactivated:

1. With the key Fan the air volume can be set manually (0%, 33%, 66%, 100%), or in the control with the set point (AUTO). These are 5 different levels.
2. If with the key fan the air volume was changed manually, the manual pre-setting air quantity remains for an adjustable time active until the program in the control passes to the set point.
3. If with the key fan the air volume was changed manually, you can stop with the key CLOCK the manual pre-setting air volume.

Case 2: Automatic mode / Week program is active:

1. With the key Mode you can stop the week program for the manual pre-setting of the air volume for an adjustable time.
2. With the key Fan the air volume can be manually changed in stages (0%, 33%, 66%, 100%), or in the control with the set point. These are 5 different levels.
3. If with the key mode or fan the air volume was set you can stop with the key CLOCK the manual pre-setting air volume.

Case 1 and Case 2: The manual operation is shown in the control and display.

The automatic mode / the week program are the program sequence in the control electronic.

Activating and switching on:



1. The zone operating device is activated in the menu control and display (obligatory).
2. After the first activation, when the display at the zone operating device is still dark the display is switched on with the Power- Key (On- Off). The manual set point is displayed instead of OFF.
3. From the synchronization the SupraBox COMFORT or the Controller can be switched on or off with the Power- key (On-Off). In the off-status the zone operating device shows the status off. In the on-status the zone operating device shows the set point and the supply temperature.

Changing set point:

1. By turning the rotary knob of the zone operating device / on the set point ENCODER the displayed new value manual temperature set point is transferred in the PCO OEM Controller / control electronic of the program sequence. This value is only applicable when the automatic mode/ week program is deactivated.

Alarms:

- 1.) An alarm is shown as an alarm bell icon in the zone operating device in the display below.

<p>Key [Up] Key arrow „up“</p>  <p>Key [Down] Key arrow „down“</p> 	<p>In the display: Switching the display in the menu overview and for the in and output pages forward or upward by operation. Changing or increasing a parameter value (setting value) for the value adjustment</p> <p>In the display: Switching the display in the menu overview and for the in and output pages forward or upward by operation Changing or increasing a parameter value (setting value) for the value adjustment</p>
<p>Key [Enter] Key arrow „middle“</p> 	<p>In the display: Confirming of the current changed parameter value for the release and choice of the optional zone operation unit with display.</p>

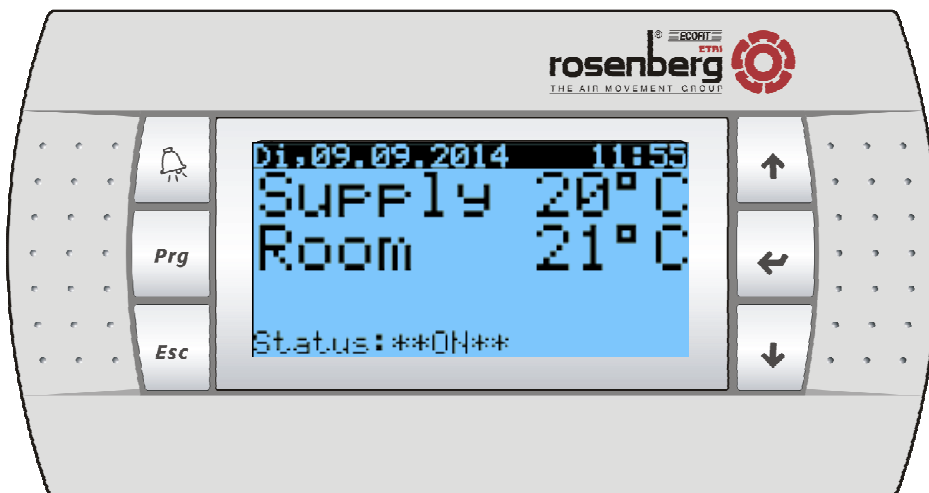





Image: Optional second operation and display

	<p>In delivery condition the current and checked Software version of the SupraBox COMFORT (SBC) is loaded in the electronic control. An additional second operating device with display for wall or front mounting can be through configuration being installed to the accessory T-Abzweig-Stück.</p>
	<p>Details can be requested at Rosenberg Ventilatoren GmbH.</p>

9 Service Menu

9.1 Enter the service menu

	<p>The service level shows information and offers additional setting possibilities. These data should not be publically accessible.</p>
	<p>The following submenus are available in the service-level:</p> <p>1 = Hours counter</p> <p>2 = Alarm history</p> <p>3 = Communication</p>
	<p>The password access for the service menu (via Password 0077) is reset automatically when no key is entered for long time. The setting value for this time interval can be found at <i>initial operation</i>><i>Service info</i>.</p>



9.2 Working hours

<p>Key [Enter] Key arrow „middle“</p> 	<p>By pressing the key [Enter] while the <i>working hours</i> is marked, the operating hours display of the used accessory can be opened.</p>
--	---

<p>Key [Enter] Key arrow „middle“</p> 	<p>In the display: Confirming of the current changed parameter value.</p>
---	---

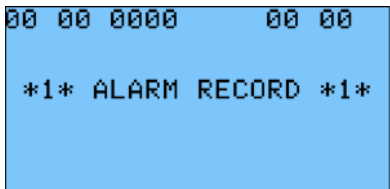
9.3 Alarm Memory

<p>Key [Enter] Key arrow „middle“</p> 	<p>By pressing the key [Enter] while the <i>Alarm history</i> is marked, the alarm history of the saved alarm can be opened. The alarms and services are sorted in the chronological order.</p>
	<p>The alarm memory has over ten storage locations, in which the alarm messages with date and time were stored.</p> <p>The alarm memory is only displayed when at least one entry is stored.</p>

<p>Key [Up] Key arrow „up“</p>  <p>Key [Down] Key arrow „down“</p> 	<p>In the display: Switching in the menu display.</p>
---	---

9.4 Bus connection

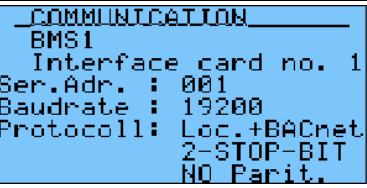
<p>Key [Enter] Key arrow „middle“</p> 	<p>By pressing the key [Enter] while the bus connection is marked, the display to the interfaces at the controller can be opened.</p>
	<p>The controller has different interfaces for the data transmission. The slot BMS1 can be set for the different transmission protocol. The optional pluggable interface card can be set on the corresponding communications protocol.</p> <ol style="list-style-type: none"> 1. BacNet 2. Modbus 3. others

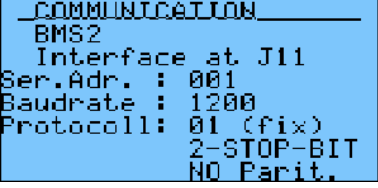
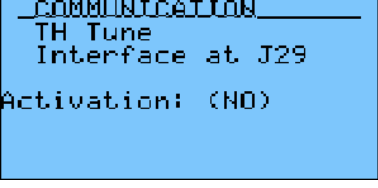
	<p>The controller has different interfaces for the data transmission. The terminal block J11 BMS2 is here set fixed on the transmission protocol Modbus. Properties can be changed.</p>
	<p>Activating of the optional zone operating unit with display. This application extends the control electronic with the possibility of:</p> <ul style="list-style-type: none"> • Set point adjusting with rotary-knob • Manually adjusting the fan steps for time intervals • Switch on and off of the automatic mode

9.5 Guided Setup

	<p>The individual pages of setup were only shown when each setting in the present system configuration is active. The individual settings can be selected also through the different menus.</p>
---	---

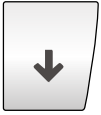
<pre>Variant setting: Horizontal outlet Suprabox 5000 Inside installation</pre>	<p>The SupraBox COMFORT (SBC) Controller has a step by step guided set-up help.</p> <p>The password access for the extended service menu (via Password 0123) is reset automatically when for longer time no key is pressed. The setting value for this time interval can be found at <u>Programming level >commissioning >Service info</u>.</p> <p>By pressing the key [Enter] while <u>guided initial setup</u> is marked, the display for the basic setting unit type SupraBox COMFORT can be opened. The selection of unit type SupraBox COMFORT enables auto command settings of the basic value for example air volume.</p> <p>The setup should be repeated again after the connection of a new accessory. Also before disconnecting the accessory, the corresponding control function must be deactivated.</p> <p>The displays have in the upper right corner a series number for the navigation.</p>
<p>Key [Up] Key arrow „up“</p> 	<p>Switching of the In and Output pages forward or upward by operation. Changing or increasing the parameter value (setting value) for the value adjustment</p>
<p>Key [Down] Key arrow „down“</p> 	<p>Switching of the In and Output pages forward or upward by operation. Changing or increasing the the parameter value (setting value) for the value adjustment</p>

<p>Key [Enter] Key arrow „middle“</p> 	<p>Choosing of the current configurable parameter value for editing after operation. Confirming of the current configurable parameter value for editing after operation. On and Off switch of the program routine or control or of the ventilation unit through a long-lasting operation.</p>
--	---

<pre>Temperature sensor external Supply : open Room : open External : open Water return: open</pre>	<p>Standard equipment at the factory is installed temperature sensor for outdoor air, return air, and supply air at the vent ducts.</p> <p>This view only indicates which temperature sensors are installed. These settings cannot be modified. A connected external sensor which is recognized by the controller implements the measurement (shown is “open” or “accepted”).</p>
<pre>Supply temp. sensor <external> Measurement : 000.0 °C Calibration : 0.0 °C Used value : 000.0 °C</pre>	<p>For every correctly connected sensor a page is called up, which shows the measured temperature. The Program Routine offers the possibility to calibrate the temperature sensors.</p>

<pre> 7 Damper actuators External air : (YES) Exhaust air : (YES) Run time : 070s Ext. air nv. : (NO) Exh. air inv.: (NO) </pre>	<p>If an air damper or a return flap has been installed, the running time of the actuator can be adjusted at this point.</p> <p>The output signal for the control of the damper drives can be inverted, if the flaps are connected with inversion and no longer accessible.</p> <p>The Program Routine controls the actuator as a spring return function so that the control after restart of the supply voltage starts from a closed flap. The fan starts with delay after the flap opening. The choice affects the opening of the chosen external air damper or return air damper and the start of the fan. In the main display the status „start-up controller „is shown in the status display.</p>
<pre> 8 Filter max. Pressure External air: 0150Pa Exhaust air : 0150Pa </pre>	<p>To the installed filter the pressure loss can be chosen for monitoring and displaying of the filter contamination. The effect of this entry is the changing of the alarm limit value. Alarm display gets active when the limit value is exceeded.</p>
<pre> 9 Heat Recovery System Reverse flow type Invert signal: (NO) Format signal: 2-10V </pre>	<p>To the installed heat recovery the type can be chosen: cross-flow heat exchanger or rotary heat exchanger. For the heat recovery there is the possibility of a bypass control with an actuator.</p>
<pre> 10 Heat Recovery System Stop run after frost 180s </pre>	<p>The Program Routine has a specific sequence for the de-frosting and prevention of freeze on the heat recovery. After alarm, if no measures were effective, the SupraBox COMFORT will after the set time, restart and the fans starts again automatically to the automatic mode. A disturbance will be signed in the alarm history. The Program Routine acknowledged automatically the pending alarm. The sequence for the de-frosting and prevention of freeze will repeat.</p>

<pre> Activation equipment Heating : (No) Cooling : (No) Preheating : (NO) Ext.cool unit: (NO) </pre>	<p>For the standard equipment you can choose the following accessory:</p> <p>Heating warm water pump (PWW) or constant electric heater EEH</p> <p>Cooling cold water pump (PKW)</p> <p>Single-stage electrical preheating EEVH</p> <p>Direct evaporator, if no cooling cold water pump (PKW) is selected.</p>
<pre> 12 Info: External air damper and exhaust air damper recommended </pre>	<p>After choosing the standard equipment a recommendation for the Heating warm water pump (PWW) will be displayed for the installation of an external air damper or return air damper.</p>

<pre> Heating water- type 13 Valve run time : 080s Format signal : 0-10V Lock protection: (YES) Frost protect. : 120s </pre>	<p>This display will only be active, if heating warm water pump (PWW) is enabled.</p> <p>The running time of the valve gear and its control signal (0-10V or 2-10V) can be set.</p> <p>The blocking protection of the warm water heater (PWW) can be activated. If it is activated, the pump will be started intermittently in order to prevent blocking.</p> <p>The working hours can be determined.</p> <p>The minimum setting and the defined limiting value of the outside temperature can be adjusted and activated.</p> <p>Pre-ventilation and the defined limiting value of the outside temperature can be adjusted and activated.</p> <p>The length of the defrost cycle can be defined in case of a frost alarm.</p>
<pre> Heater water- type 14 Min. opening value Min. value: 25 % ext. temp.: <05.0 °C Activation: (NO) </pre>	<p>To the chosen system heating warm water pump (PWW) the function minimal opening of the heating valve can be selected. This function is recommended for the use in the cold winter season. The value minimum position for the opening of the heating valve and the needed limit value of the outdoor temperature can be entered and activated. The outdoor temperature sensor must be connected.</p>
<pre> Heating water- type 15 Preheat exchanger Activation: (YES) Run time : 01 min ext. temp.: < 10.0 °C </pre>	<p>To the chosen system heating warm water pump (PWW) the preheat function can be selected. This function is recommended for the use in the cold winter season. The choice affects the opening of the selected external air damper or return air damper and the start of the fan. In the main display the status „preheat „is shown. The function preheat is effected for the configured time when the outdoor temperature fall below the limit value. The outdoor temperature sensor must be connected.</p>
<pre> Heating water- type 16 Frost protection Activation : (NO) Ext. temp. : <05.0 °C Setp. Temp. : 25.0 °C P-Band:15.0 I: (NO) </pre>	<p>To the chosen system heating warm water pump (PWW) an active antifreeze function can be selected. This function is recommended for the use in the cold winter season. When the outdoor temperature fall below the limit value the heating register will be regulated to the configured set point for the return temperature. With the selection of the control method Integration (I) a dynamic control will be activated. The outdoor temperature sensor and the return flow temperature must be connected.</p>
<pre> Electrical heater 17 Stop run fans after operation: 020s </pre>	<p>To the chosen Single-stage electrical preheating EEH the function run fans after operation can be selected. In the main display the status „STOP RUN“ is displayed. The fans supply the single-stage electrical preheating EEH an air flow for the cooling after switch off.</p>
<pre> Cooling water- type 19 Valve run time : 080s Format signal : 0-10V Lock protection: (YES) </pre>	<p>0</p>
<pre> External cool unit 20 CompTrol Interface III with defrost : (YES) Stop run after defrost operation : 060s Contact type : (N.O.) </pre>	<p>This display will only be active if the direct evaporator is enabled.</p> <p>The selection of the interface board for the direct evaporator- System for example CompTrol Interface III (manufacturer Mitsubishi / Stulz) der PAC IF011B (manufacturer Mitsubishi) is set in this display. The property defrosting to this interface board can be adjusted.</p>

<pre> External cool unit Setpoint hand shake Temperature relation min. 00.0V 18.0°C max. 10.0V 30.0°C Alarm activ.: (NO) </pre>	<p>21 This display will only be active if the direct evaporator is enabled.</p> <p>The corrective signal type (0-10V, 2-10V, others) and the scaling after the required temperature for the set point setting on the interface board is shown in this display.</p>
<pre> Preheater Type operation: Prevent. Stop run fans after operation : 020s Activate below: 4.0 °C Min. operation: 0300s </pre>	<p>22 This display will only be active if the single-stage electrical preheating EEVH is enabled.</p> <p>The counter flow heat exchanger is monitored due to icing with the help of a pressure difference control device. During the setup it can be defined, which de-frosting strategy should be used. In the selection prevention, the pre-heating will be activated for the minimum configured time when the limit value fall below. The fans supply the single-stage electrical preheating EEVH with air flow to cool after switching off for the adjusted follow-up time. In the selection de-frosting, the preheating is activated through the pressure difference control device.</p>
<pre> Control temperature Supply temperature </pre>	<p>23 For the temperature control it can be chosen between a supply-, return-or room temperature control.</p>
<pre> min.Setpoint: 16.0°C max.Setpoint: 28.0°C Resolution : 0.5°C </pre>	<p>24 For the temperature control, the selectable manual set point for the comfort temperature can be limited for heating and cooling. The limit effects on the display for the settings.</p>
<pre> Limit supply temp. Minimal: 16.0°C Maximal: 38.0°C </pre>	<p>25 For the temperature control it can be chosen between a supply-, return-or room temperature control. If return or room temperature control was chosen, the limit values for the supply set point temperature determine the adjusting range of the automatic control method (cascade control).</p>

<pre> Control type P or PI calc. supply temp. P-Band : 0400 I-Activ.: OFF I-Time : 0500s </pre>	<p>26 For the dynamic control method (cascade control) the proportional part and the integration part as well as the release is set in this display.</p> <p>A high integration part obtained through an increased integration time slowed down the dynamic. These slowed down dynamic is increased through the proportional part. A recording of the control temperature is recommended so that a change in the integration part with the temperature fluctuations can be determined.</p>
	<p>Wrong settings can lead to oscillations for the comfort</p>
<pre> Interval between heat to cool: 02 min cool to heat: 02 min </pre>	<p>29 For the dynamic control method (cascade control) a time limit between heating and cooling is set as dead zone in this display. Especially through the dynamic, obtained by the temporal integration part, a break between heating and cooling is recommendable, to avoid oscillations for the comfort temperature due to avoid constant change between heating and cooling.</p>

<div style="text-align: right; border: 1px solid black; padding: 2px;">36</div> <p>Supply fan and return fan boost function: (NO) (high rotation speed)</p>	<p>In the basic setting unit type SupraBox COMFORT (SBC) the default values were called up. For the control voltage and speed the manufacturer values are stored in the memory. The selection Boost with the higher values as maximum values for the control voltage and speed is set in this display. The Boost Modus via heat recovery affects the efficiency.</p>
<div style="text-align: right; border: 1px solid black; padding: 2px;">37</div> <p>Fan operation with unequal rotation: (YES) 0300s Defrost UNEQU. 0600s switched OFF</p>	<p>The counter flow heat exchanger is monitored due to icing with the help of a pressure difference control device. During the setup it can be defined which de-frosting strategy should be used. For the program routine defrost sequence the speed of the supply fan is reduced by 30% after the pressure difference control device is released. The release and the duration of the fan operation in imbalance and a compulsive break for the automatic mode are set in this display.</p>
<div style="text-align: right; border: 1px solid black; padding: 2px;">38</div> <p>Type operation fans Supply: Volume driven Return: Volume driven</p>	<p>The automatic mode of the fans can be set separately. The possibilities are:</p> <ul style="list-style-type: none"> - 0-10V Signal - Volume flow - Pressure - Slave operation <p>The effect of these setting is the application of the corresponding sensor and the control method.</p>
<div style="text-align: right; border: 1px solid black; padding: 2px;">39</div> <p>Parameter pressure control with fans: P-Band: 0300 I-Time: 30s Range : 0-1000Pa</p>	<p>The automatic mode of the fans can be set separately. For the setting pressure the display appears.</p> <p>For the dynamic control method (PI-Control) the proportional part and the integration part is set in this display for the measuring range of the sensors.</p>

<pre> Automatic operation driven by: External signal 0-10V Sensor type: CO2 </pre>	<p>The automatic mode of the fans can be set. For the setting external signal 0-10V to change the set point this display is shown.</p> <p>The basic selection is:</p> <ul style="list-style-type: none"> - Temperature difference - 0-10V Signal <p>The external signal 0-10V can be defined as:</p> <ul style="list-style-type: none"> - CO2 - VOC - Relative humidity <p>The effect of this setting is the application of the corresponding sensor and control method.</p>
<pre> Sensor range CO2 sensor type: Min. value: 00000PPM Max. value: 2000 PPM Start : 000.0% End : 100.0% </pre>	<p>The automatic mode of the fans can be set when changing the set point. For the setting external signal 0-10V and CO2 the display is shown.</p> <p>The control value of the fan speed in percent of the unit type SupraBox COMFORT volume flow and the corresponding sensor scale were set in this scale.</p>
<pre> Sensor range VOC sensor type: Min. value: 000.0% Max. value: 100.0% Start : 000.0% End : 100.0% </pre>	<p>The automatic mode of the fans can be set when changing the set point. For the setting external signal 0-10V and VOC the display is shown</p> <p>The control value of the fan speed in percent of the unit type SupraBox COMFORT volume flow and the corresponding sensor scale were set in this scale</p>
<pre> Sensor range rel.H. sensor type: Min. value: 000.0% Max. value: 100.0% Start : 000.0% End : 100.0% </pre>	<p>The automatic mode of the fans can be set when changing the set point. For the setting external signal 0-10V and relative humidity the display is shown.</p> <p>The control value of the fan speed in percent of the unit type SupraBox COMFORT volume flow and the corresponding sensor scale were set in this scale</p>
<pre> Parameter Automatic operation Volume flow [m³/h]: Supply fan min.: 0200 Supply fan max.: 5300 Return fan min.: 0200 Return fan max.: 6000 </pre>	<p>The automatic mode of the fans can be set. The control value of the fan speed in percent of the unit type SupraBox COMFORT can be shown in this display within the limits of the manufacturer.</p>
<pre> SupraBox 800 H Volume flow control P-Band : 00000 I-Time : 00030s </pre>	<p>In the basic setting unit type SupraBox COMFORT the standard values were called up. For the dynamic control method (PI-Control) the proportional part and the integration part were set in this display.</p> <p>A high integration part obtained through an increased integration time slowed down the dynamic. These slowed down dynamic is increased through the proportional part. A recording of the control temperature is recommended so that a change in the integration part with the temperature fluctuations can be determined.</p>



Wrong settings can lead to oscillations at the fan speed, the air flow and air supply. The noises of the fan when switching on show the result of the setting.



<div style="border: 1px solid black; padding: 5px;"> 46 <pre> Operation fans at fire/ smoke detect. Supply fan: (OFF) Return fan: (OFF) </pre> </div>	<p>In case of an alarm through central fire alarm system, smoke detector or a fire damper, the performance of both fans can be defined individually. It can be chosen, if the fans should be accelerated to the maximum speed or it should be deactivated and the air damper/return air damper should be closed.</p>
	<p>In case of a BSK alarm the operating mode must be selected corresponding to the valid, legal regulations.</p>

9.6 Manual operation

<div style="border: 1px solid black; padding: 5px;"> <pre> __MANUAL OPERATION__ Activation (NO) (Do not endanger the airhandling unit) </pre> </div>	<p>By pressing the key [Enter] while <i>manual level</i> is marked, the release manual operation on the controller can be opened. The following displays are not generally available. With the key [Up] or key [Down] you can switch to the menu display.</p>
<div style="border: 1px solid black; padding: 5px;"> <pre> __MANUAL OPERATION__ Digital outputs 1 2 3 4 5 6 7 8 0 0 0 0 0 0 0 0 9 10 11 12 13 0 0 0 0 0 __MANUAL OPERATION__ Analogue outputs Y1: 00.0 U Y2: 00.0 U Y3: 00.0 U Y4: 00.0 U Y5: 00.0 U </pre> </div>	<p>The digital and analogue output can be individually set, but only if the parameter release is set to „Yes“(setting at the end of the input/output list).</p>
	<p>User and operator have the full responsibility for Consequences of the operating error.</p>

9.7 Setup Menu

	<p>By pressing the key [Enter] while <i>setup</i> is marked, the menu overview to the singular configurations on the controller can be called up. The following displays are not generally available. With the key [Up] or key [Down] you can switch to the menu display.</p>
---	--

	<p>The possibilities to be chosen are:</p> <p>1 = Variant 2 = Temp. sensors 3 = Damper actuators 4 = Filter 5 = HRS 6 = Equipment 7 = Temp. settings 8 = Comfort settings 9 = Fan settings</p>
	<p>The individual pages of the setup are only displayed when the respective settings in the present system configuration, for example for menu selection accessory, are effective.</p> <p>The individual settings can also be selected through the different menus.</p>

10 Parameter list

	<p>Individual displays are only displayed when the respective defaults were selected (see service menu guided setup or setup).</p> <p>The selection of the unit type SupraBox COMFORT sizes 800 to 5000 makes automatically the settings for the basic values, for example air quantity.</p> <p>The setup should be made again after connecting a new accessory. Also the corresponding control function must be deactivated before disconnecting the accessory.</p> <p>The list below shows the essential parameters and defaults or dependencies hereto. It is recommended to enter the parameters after the first setup in a list:</p>	
<p>Operation level</p>	<p>Temperature nominal value</p>	<p>21°C</p>
<p>Service menu</p>	<p>(Selection of the control sensor) (Sensor supply air intern)</p>	<p>Supply air temperature recognized</p>
<p>Service menu</p>	<p>(Selection Summer/ Winter compensation) (Start value Summer) (End value Summer)</p>	<p>22.0°C 34.0°C</p>
<p>Service menu</p>	<p>(Selection Summer/ Winter compensation) (Start value Winter) (End value Winter)</p>	<p>18.0°C 04.0°C</p>
<p>Service menu</p>	<p>(Selection Summer/ Winter compensation) (Max. moving Summer) (Max. moving Winter)</p>	<p>1.0°C 1.0°C</p>

Service menu	(supply air limit) (Minimum) (Maximum)	16.0°C 38.0°C
Service menu	(Control type heating) (Type) (P-Band) (Integration time)	PI-Control 40.0°C 100s
Service menu	(Control type cooling) (Typ) (P-Band) (Integration time)	PI-Control 40.0°C 100s
Service menu	(break time) (heating and cooling) (cooling and heating)	2Min. 2Min.
Operation level	Nominal value Supply air fan	...%, Pa, m ³ /h As required
Operation level	Nominal value return air fan	...%, Pa, m ³ /h As required
Service menu	(operating mode of the fan)	Volume flow
Operation level	Automatic calculation of the fan nominal value	No
Service menu	(Automatic mode dictated by) Sensor 0-10V	Temperature difference free
Operation level	Selection time control and Week program	No
Operation level	Selection night air	No
Service menu	(Temperature sensor room air)	free
Service menu	(Night air limit value Room temperature.)	24.0°C
Service menu	(Night air limit value Outdoor temperature.)	16.0°C

Operation level	Selection Standby mode heating	No
Service menu	(Accessory heating)	PWW
Service menu	(Temperature sensor Room air)	free
	(limit value heating)	17.0°C
	(limit value cooling)	24.0°C
Operation level	Selection Standby mode cooling	No
Service menu	(accessory cooling)	PKW
Service menu	(Temperature sensor room air)	free
	(limit value heating)	17.0°C
	(limit value cooling)	24.0°C

Service level	Variant size	5000m³/h
Service level	Air connection	Horizontal
Service level	Temperature sensor external	
	Supply air room air	free
	Outdoor air	free
	Return flow	free
		free
Service level	Damper actuator	
	Outdoor air	Yes
	Return air	Yes
Service level	Max Pressure Filter External filter	150Pa
	Max Pressure Filter External filter	150Pa
Service level	Accessory	
	Heating	No
	Cooling	No
	Pre-heating	No
	Direct heat exchanger	No
Service level	Usage type preheating	Prevention
Service level	SupraBox Volume flow control	
	P-Band	9900
	I-time	500s

Service level	Performance Fans when BSK Alarm	
	Supply air	OFF
	Return Air	OFF
Service level	Flush function	
	Release	Yes
	Limit value outside temperature	10°C

11 Storage, Transport

See BA 112 AA 11 Operational and maintenance guideline for compact ventilation application of the series SupraBox COMFORT (SBC) of Rosenberg Ventilatoren GmbH.

12 Maintenance, Servicing



Maintenance and servicing should only be done by trained and instructed staff and when taking all relevant rules and regulations into consideration!

Usually our control box is maintenance free! Under extreme conditions minor maintenance work may be necessary!

When working at the control box of the SupraBox COMFORT (SBC) the guidelines for the electrical safety must be maintained and divide from the voltage

If repairs are necessary they have to exclusively be made by a Rosenberg Ventilatoren GmbH authorized technician.

All changes and repairs at electric connections may only be made by an authorized electrician. Checking of the insulation resistance according to DIN EN 60204 -1 or VDE 0113 -1 4.1 is recommended.

For the maintenance and service the protective conductor system and the automatic shutdown in case of error must always be checked.

13 Accessories and Field devices

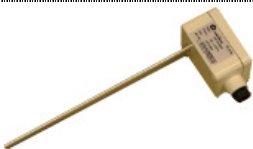

The **sensors for fresh air or return air temperature** are constructed as duct sensors. The wiring at the switch cabinet should be made using a shielded cable (J-Y (St) Y 4x 0, 6). The shield has to be connected to the switch cabinet and to the ground terminal in the sensor housing. Polarity of the connections at the switch cabinet and the duct sensor does not affect the measurement precision. As the Supraboc Comfort is already equipped with sensors in the union, special duct sensors for the use of heat exchangers (e.g. heating coils, cooling coils) are recommended. If a heating/cooling coil of Rosenberg Ventilatoren GmbH is ordered, a corresponding duct sensor is included in the delivery scope of the coil.

Rosenberg Item Code: H42-09926



The **room temperature sensor** is suitable for wall fastening. The wiring is made with use of a shielded cable like for the duct sensor. Also in this case the polarity does not affect the measurement precision. The use of a room temperature sensor is precondition for the function of the backup mode and ventilation at night.

Item code: H42-09902

	<p>The outside temperature sensor is suitable for wall fastening. As for the duct sensor the wiring must also be made with a shielded cable. Also here the polarity does not affect the measurement. The use of a room temperature sensor is pre-condition for the function ventilation at night.</p> <p>Item code: H42-09914</p>
	<p>The CO2 Sensor can be used in order to keep the CO2 volume of the room low during automatic operation. The CO2 sensor must be wired according to the valid wiring diagram.</p> <p>Item code: H42-09930</p>
	<p>The Hygrostat can be used for the over-modulation of the fans, thus in case of excess of the defined nominal value the ventilation will automatically be switched. The Hygrostat must be connected according to the current wiring diagram.</p> <p>Item Code: H42-09922</p>
	<p>The dual differential pressure sensor with Modbus – Connection for the use of the pressure constant control of the fans, the filter monitoring and the temperature sensor in the intake manifold are already in the SupraBox COMFORT (SBC) installed.</p> <p>Item code: H40-12500</p>
	<p>The analog differential pressure sensors are designed for the supply and exhaust air ventilation. The configuration at the initial operation can be set on the control panel. The connection of the differential pressure sensor must be made according to the current wiring diagram. The selection of the pressure range is in accordance with the construction of the Rosenberg Software Tool RoVent and must be taken into account. The measuring range is 1000Pa. Other measuring ranges on request..</p> <p>Item code: H40-00100</p>
	<p>The Contact thermostat will be directly attached to the main in the return flow of the hot water coil and controls the return temperature. If the return temperature falls off the defined limit an alarm occurs and the hot water coil will be activated with maximum power in order to avoid freezing.</p> <p>If a hot water coil of Rosenberg Ventilatoren GmbH is ordered, a contact thermostat is included in the scope of delivery of the coil. The polarity of the connections at the switch cabinet and the contact thermostat does not affect the function.</p> <p>Item code: H40-00024</p>
	<p>The function of the frost protection thermostat corresponds to that of the contact thermostat with the difference that the capillary tube is fixed directly at the hot water coil in the ventilation duct. The polarity of the connections does not affect the measuring.</p> <p>Item Code: FST000-0212N</p>



If a return temperature control is applied, the use of a **contact sensor** is necessary. This must be fixed at the return of the hot water coil in the same way as the contact thermostat. The wiring to the switch cabinet should be made with use of a shielded cable (J-Y (St) Y 4x 0, 6). The polarity of the connections at the control box and at the contact sensor does not affect the function.

Item Code: H42-09917



The **Bypass flap- servo motor** is pre-assembled in the SupraBox COMFORT and finally wired. The damper servo motor used for the bypass flaps has no limit switch and an overload protection. If the end position of the flap or the motor is reached they stop automatically.

The functions of the flaps can be controlled by slightly pushing the house cover. For this the gear must be unlocked and the fan can be moved manually.

The following wiring diagram for the bypass flap damper servo motor is valid:

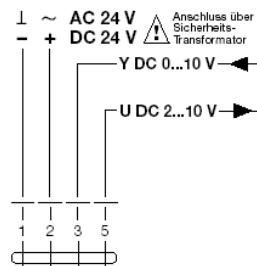

When a **fresh air/ return air flap with a damper servo motor with spring return** is used the following picture is valid::

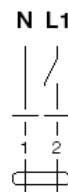

When a **fresh air/ return air flap with damper servo motor without spring return** is used, the following picture is valid:

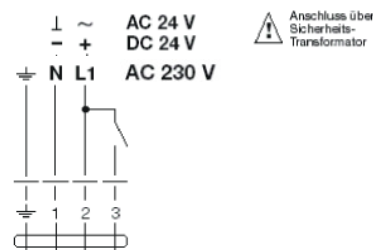

The **differential pressure control** is used for the frost control of the cross flow heat exchanger. The differential pressure control is applied with a changeover contact. It must be connected to the contacts no.1 and no.3. The lower pneumatic supply + (P1) at the differential pressure control must be fixed in front of the heat exchanger (return air side). The connection – (P2) at the differential pressure control must be fixed behind the heat exchanger (exit air side). The differential pressure control is always pre-assembled and finally wired ex works.

Item code: DDW050-0500N



A robust construction was chosen for the Rosenberg- **valve-drive motor** Type AME 435. The servo drive also provides the option of an emergency manual operation. In this case the valve must be adjusted with a control knob installed outside the house. The raw percentage opening of the valve can be read on a scale at any time. To ensure a correct function the DIP switches attached to the gear must be set as follows:

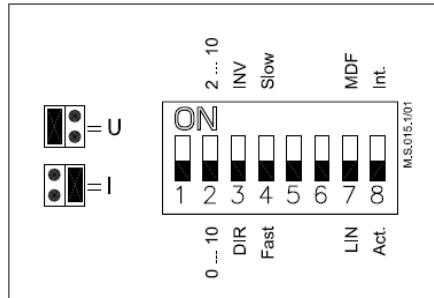

1 -> OFF; 2 -> OFF; 3 -> OFF; 4 -> OFF; 5 -> OFF; 6 -> OFF; 7 -> OFF; 8 ->OFF

Item code: H81-26010



For the connection of the switch contact controls (e.g. contact thermostat) basically select an opening contact, thus the switch contact is closed during the usual operation.



If field devices of the other manufacturers are installed, carefully check the separate protective circuit!!

14 Copyright



It is forbidden to copy the manual or parts of it by photomechanical means (copy, microcopy) or to publish it in newspapers and magazines or other media.



If there are further questions after you have read the manual, please consult our sales representative.

15 Customer Service, Manufacturer's address



The products of Rosenberg Ventilatoren GmbH are constantly checked for quality and correspond to the relevant regulations.

For all questions regarding our products, consult the originator of your ventilation system at one of our subsidiaries or direct to:

Rosenberg Ventilatoren GmbH

Maybachstraße 1

D-74653 Künzelsau- Gaisbach

Tel.: 07940/142-0

Telefax: 07940/142-125

email:

Info@rosenberg-gmbh.com

Internet:

www.rosenberg-gmbh.com

16 Initial Operation Report

Size	<input type="checkbox"/> 800 m³/h	<input type="checkbox"/> 1100 m³/h	<input type="checkbox"/> 1500 m³/h	<input type="checkbox"/> 1900 m³/h	<input type="checkbox"/> 2000 m³/h	<input type="checkbox"/> 3500 m³/h	<input type="checkbox"/> 5000 m³/h
-------------	--	---	---	---	---	---	---

Direction	<input type="checkbox"/> Horizontal		<input type="checkbox"/> Vertical		<input type="checkbox"/> Ceiling assembly		
Control temperature	<input type="checkbox"/> Fresh air temperature		<input type="checkbox"/> Return air temperature		<input type="checkbox"/> Room temperature		
Fans	Maximum value: _____		Minimum value: _____		Imbalance: _____		
Fresh air fan	<input type="checkbox"/> Speed control, checked	<input type="checkbox"/> Air volume control, checked	<input type="checkbox"/> Pressure control, checked	<input type="checkbox"/> Fixed valve, checked	<input type="checkbox"/> Follow up, checked		
Return Fan	<input type="checkbox"/> Speed control, checked	<input type="checkbox"/> Air volume control, checked	<input type="checkbox"/> Pressure control, checked	<input type="checkbox"/> Fixed valve, checked	<input type="checkbox"/> Follow up, checked		
<input type="checkbox"/> Fans free-moving in disconnected status.							
<input type="checkbox"/> Operation manuals are available _____							
<input type="checkbox"/> Sensor Overriding			Sensor type: _____				
<input type="checkbox"/> Sensor Automatic operation			Sensor type: _____				
<input type="checkbox"/> Filter flow direction considered							
<input type="checkbox"/> Limiting Value of the differential pressure control for monitoring WRG freeze, checked and set. Value _____							
<input type="checkbox"/> Supply air duct sensor placed behind the coil if fresh air heating/cooling is used.							
<input type="checkbox"/> Direction of rotation of the bypass damper checked and set.							
<input type="checkbox"/> Direction of rotation of the outside air/return air damper checked and set (in case that accessories are connected)							
<input type="checkbox"/> Condensate drain correctly connected (trap, anti-freezing protection)							
<input type="checkbox"/> Warm water coil connected (flow, return flow correct, valve switching checked)							
<input type="checkbox"/> Anti-Freeze protection correctly connected and checked.		<input type="checkbox"/> Anti-freeze thermostat(behind the heating coil)			<input type="checkbox"/> Contact thermostat(at the return flow, close to the coil)		
<input type="checkbox"/> Cold water cooling coil connected (flow, return flow correct, valve switching checked)							
<input type="checkbox"/> Electric heating connected							
<input type="checkbox"/> Overheat control and air volume control connected and checked							
<input type="checkbox"/> Electro-preheating connected							
<input type="checkbox"/> Overheat control and if necessary air volume control (not for integrated PTC) connected and checked							
<input type="checkbox"/> Direct evaporator/ refrigerator connected and checked							

