

## EC-Tube Fans R...G / Z...G



## Contents

3	Description - R...G
3	Application Areas
3	Casing
4	Impellers
4	Motor and Motor Protection
4	Electrical Connection
4	Installation
5	Air Volume Control
5	Scope of Delivery
5	Construction Scheme
6	Description - Z...G E / Z...G R
6	Possible Application Areas
6	Casing
7	Impellers
7	Motor and Motor Protection
7	Electrical Connection
7	Installation
8	Air Volume Control
8	Scope of Delivery
9	Construction Scheme

## R...G – EC-Tube Fans

Construction of steel

- easy installation in any position
- easy electrical connection via terminal box
- energy saving with EC-motors
- motor protection by thermal contacts
- isolation class F



### Description:

The Rosenberg EC-Tube fans represent a technically perfect solution, uniting the advantages of axial fans, straight airflow and easy installation, with high pressure stability, low noise level and high efficiency of the radial fans.

### Application areas:

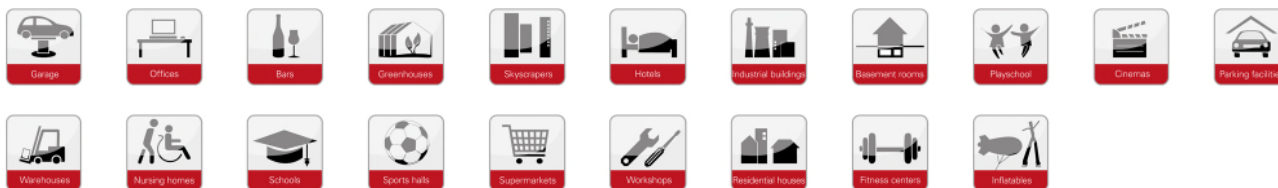

### Casing:



#### Steel type (R...G)

The casings are manufactured of galvanized sheet steel

### Impellers:

The impellers are balanced together with the external rotor motors at two levels according to quality level G2.5/G 6.3 DIN ISO 21940-11.



#### Type R...G:

Backward curved centrifugal impeller made of plastic.

### Motor and Motor Protection:

EC external rotor motors according to DIN EN 60034-5 are used, ball bearing mounted and with integrated thermal contact for motor protection.



The sleeplessly controllable EC motors are characterized by a very high degree of efficiency, even in the partial load range, as well as good control and regulation behavior. They are easy to connect, individually preconfigured, compact in design and demonstrate a high power density. The implementation of additional functions (e.g. volume flow and pressure control) is possible. All motors can be speed controlled in the range 0-100 %.

The motor protection is integrated. All necessary parameters such as temperature, blocked rotor, over- and undervoltage and power are continuously checked and monitored via intelligent fault management.

### Electrical Connection:

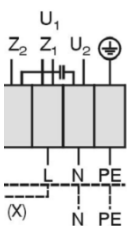

#### Series R...G:

The electrical connection is mounted on the housing by a terminal box with IP54 protection.

### Installation:



Rigid folded spiral-seam ducts (Spiro), flexible aluminium or plastic ducts with standardized diameter can be used.

### Air Volume Control:

For more information see accessories!



#### Open-loop control

For example with a Potentiometer 0-10V signal

### Scope of Delivery:

- Tube fan (R...G)
- Documentation

### Construction Scheme:

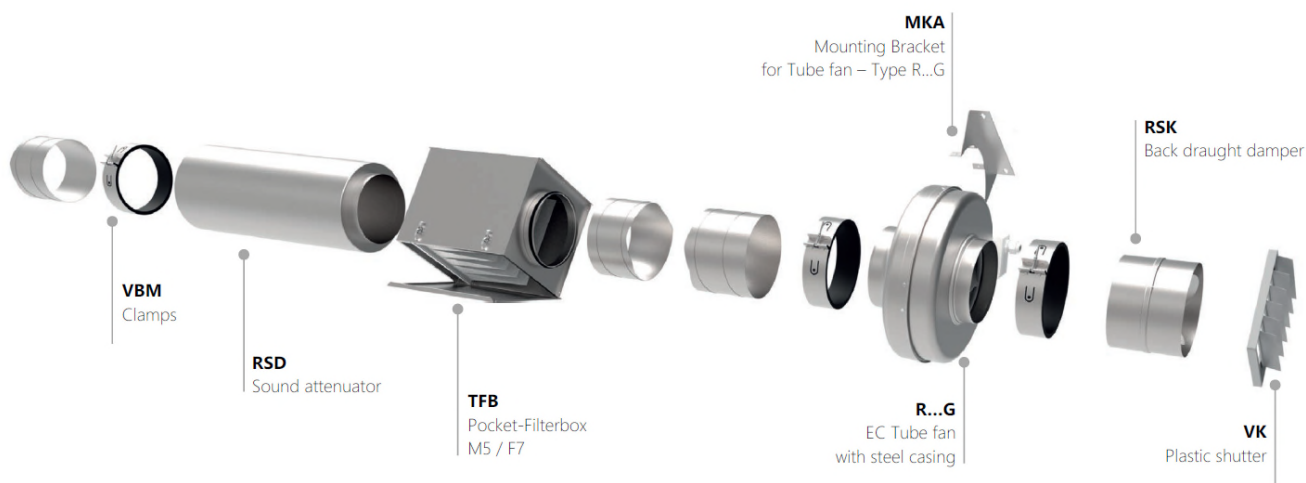

## Z...G E / Z...G R – EC-Zeroboxes

Tube fan with sound-insulated housing

- low noise
- can be installed in any position
- easy cleaning and maintenance
- easy electrical connection via IP44 terminal box
- motor protection by thermal contacts



### Description:

The Rosenberg EC-Zeroboxes are used for ventilation of apartments, warehouses, factories, toilets, bathrooms, locker rooms and more. The extremely flat construction makes them ideal for installation in suspended ceilings. The very low noise fans can be installed in any position.

**Note:** Due to the open sound insulation, use as a supply air fan (according to VDI 6022) is not possible.

### Application areas:



### Casing:

Casing is made of sendzimir sheet steel as sound absorbing construction. The covering lid can easily be unscrewed to gain access for cleaning and maintenance. The motor is removable together with the impeller and spiral scroll.

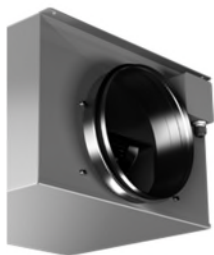

#### Z...G E / Type Evolution

is equipped with 40mm thick rockwool plates

#### Z...G R / Type Revolution

is equipped with 40mm thick rockwool plates

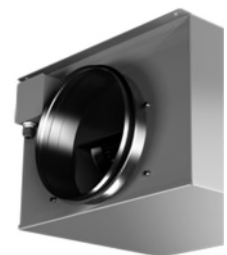

### Impellers:

Both types of impellers are balanced dynamically and statically together with the external rotor motors at two levels according to quality level G2.5/G6.3 DIN ISO 21940-11.



#### Series Evolution:

Up to size 250: The impellers are forward curved with double inlet.  
From size 315. The impellers are backward curved with single inlet.



#### Series Revolution:

The impellers are backward curved with single inlet.

### Motor and Motor Protection:

EC external rotor motors according to DIN EN 60034-5 are used, ball bearing mounted and with integrated thermal contact for motor protection.



The sleeplessly controllable EC motors are characterized by a very high degree of efficiency, even in the partial load range, as well as good control and regulation behavior. They are easy to connect, individually preconfigured, compact in design and demonstrate a high power density. The implementation of additional functions (e.g. volume flow and pressure control) is possible. All motors can be speed controlled in the range 0-100 % and have a ModBus RTU interface.

The motor protection is integrated. All necessary parameters such as temperature, blocked rotor, over- and undervoltage and power are continuously checked and monitored via intelligent fault management.

### Electrical Connection:

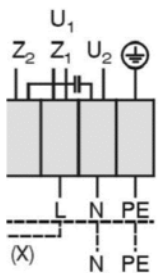

#### Series Evolution / Revolution:

The electrical connection is mounted on the housing by a terminal box with IP44/IP54 protection.

### Installation:



Rigid folded spiral-seam ducts (Spiro), flexible aluminium or plastic ducts with standardized diameter can be used. EC-Zeroboxes can be installed in any position. If the EC-Zerobox is used for several floor levels, the local laws on fire protection have to be observed.

### Ceiling Mount

of the tube fan type Z...G E/R with threaded rod.  
 Mounting hardware is **not** included!

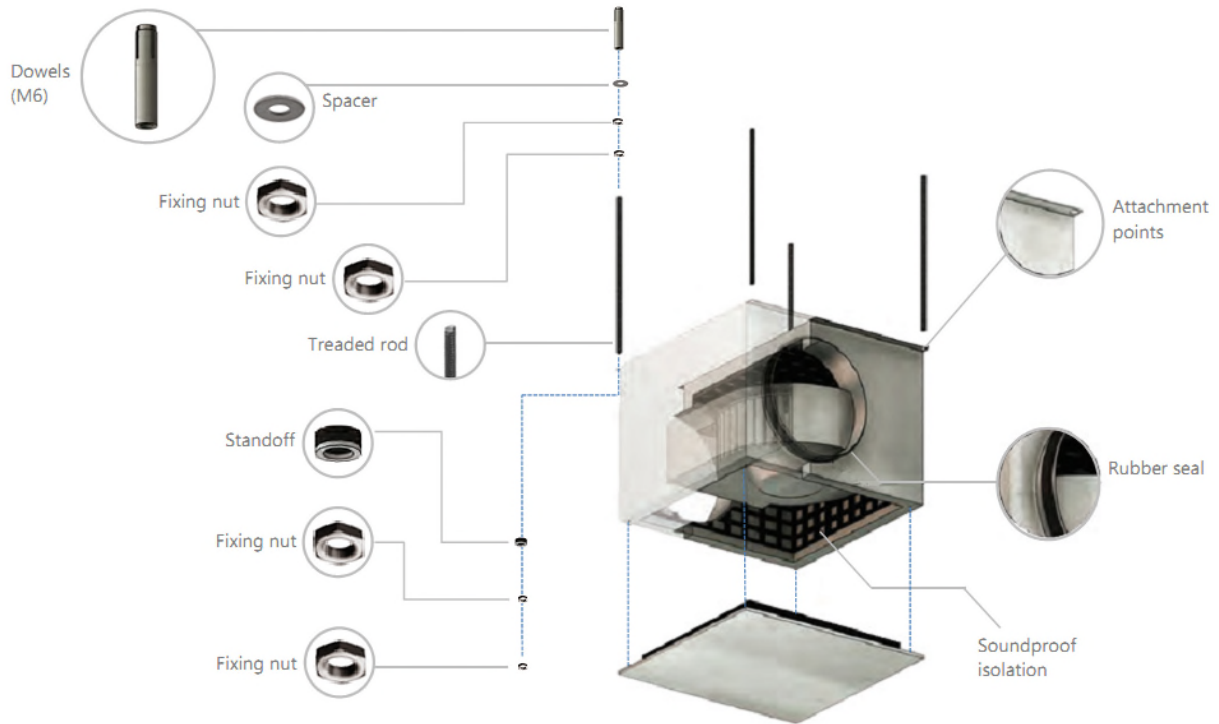

### Air Volume Control:

For more information see accessories!



#### Open-loop control

For example with a Potentiometer 0-10V signal

### Scope of Delivery:

- Zerobox (Z...G E / Z...G R)
- Documentation



### Construction Scheme Zeroboxes:

